

The Derby Steel™ Welded Wall Desk/Shelf

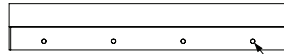

Ø 0.375"

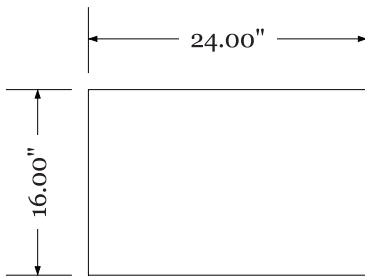
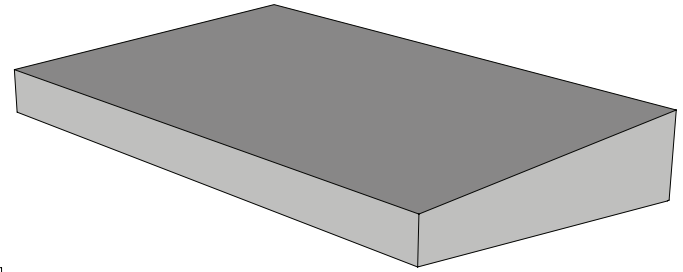

SOUND DEADENING RTV SILICONE
LAYER BETWEEN UNDER-MOUNT
& DESK TOP

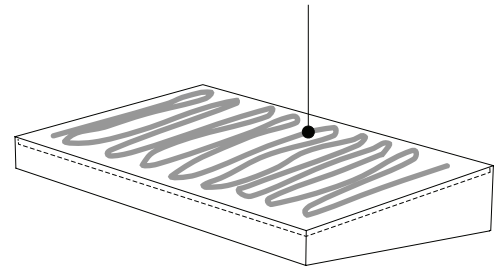
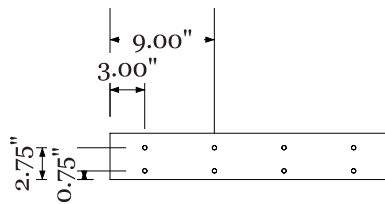

OVERVIEW

Heavy duty wall mounted one-piece steel desk/shelf. For use in institutional or correctional facilities.

FABRICATION

All welded construction. Desk/shelf mounts directly to wall. The wall desk/shelf has a baked on polyester powder coat finish.

MATERIAL

- 16 x 24" 10 gauge steel desktop with $\frac{3}{8}$ " diameter mounting holes for mounting to wall.
- Steel $\frac{1}{4}$ " desk/shelf undermount.

COLOR

Vitracat T.K. Gray.

WEIGHT

TBD

OPTIONS

- 14 gauge stainless steel desktop/shelf Type 304 2B Finish.
- Prime coat.

ASSEMBLY

No assembly required.

INSTALLATION

Bolt or weld unit to wall.*

WARRANTY

1 year limited replacement warranty.

MAINTENANCE

Easy clean up with a damp cloth and mild detergent.

*Floor and wall mounting hardware not included.

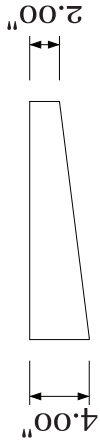
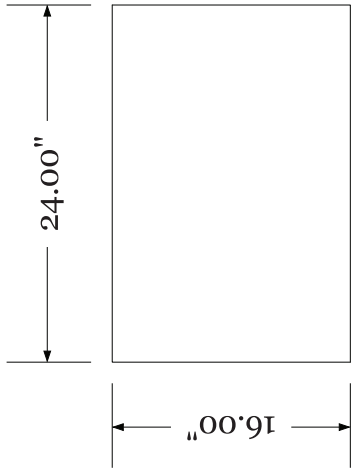

SOUND DEADENING RTV SILICONE
LAYER BETWEEN UNDER-MOUNT
& DESK TOP

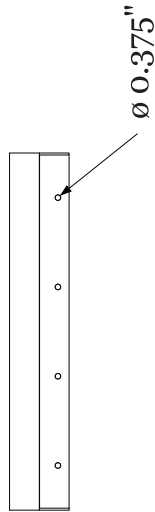
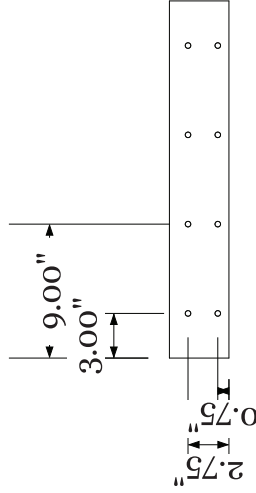
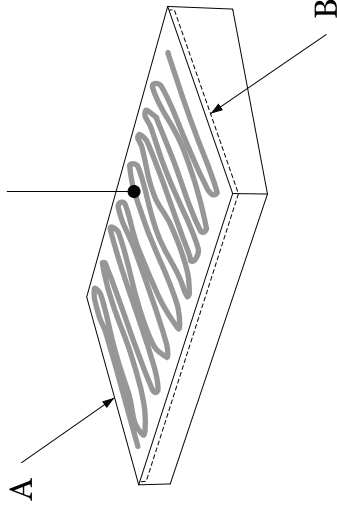

ITEM	DESCRIPTION	QTY	REVISIONS	
A	B	1	MM/DD/YY	REMARKS
	DESK TOP, 304 STAINLESS STEEL, 1/4"	1	___/___/___	...
	TABLE UNDER-MOUNT, SHEET METAL, 1/4"	1	___/___/___	...
				
DERBY INDUSTRIES Wall Desk/Shelf (Welded)				
STANDARD TOLERANCES .X = ±.12" .XX = ±.06" .XXX = ±.03" ANGLE = ± 1°				
			1	...
			2	...
			3	...
			4	...
			5	...

100

A